

Part Number: PT398-60140

Conflicts

Will not program with Techstream Lite.
--

Recommended Sequence of Application

Item #	Accessory	
1	XM	XM Radio
2	TVIP	V2 Glass Breakage Sensor (GBS) and/or V4 Remote Engine Starter (RES)

Kit Contents

Item #	Quantity	Description
1	1	Wire Harness
2	1	RES ECU Bracket
3	1	Extra Large Wire Tie

Hardware Bag Contents

Item #	Quantity	Description
1	1	RES ECU
2	1	Gateway ECU
3	1	Gateway ECU Bracket
4	1	M6 Tapping Screw
5	15	Wire Ties
6	1	Waterproof Sheet
7	2	Large Foam Tape (1sheet - 2pcs)
8	1	Custom Double Stick Tape
9	2	Key Tag (English)
10	2	Window Labels (English)
11	2	Transmitter Labels (English)
12	1	Engine Room Warning Label (English)
13	2	Key Tag (Spanish)
14	2	Window Labels (Spanish)
15	2	Transmitter Labels (Spanish)
16	1	Engine Room Warning Label (Spanish)
17	1	Owner's Guide







Additional Items Required For Installation

Item #	Quantity	Description
1	1	Black Electrical Tape

Recommended Tools

Personal & Vehicle Protection	Notes
Safety Glasses	
Safety Gloves	(Optional)
Vehicle Protection	Blankets, Parts Boxes
Special Tools	Notes
Techstream	Do not use Techstream Lite
Installation Tools	Notes
Screwdriver	#2 Phillips
Nylon Panel Removal Tool	e.g. Panel Pry Tool #1 Toyota SST # 00002-06001-01
Side Cutters	
Torque Wrench	36 in•lbf (4.07 N•m) 88.5 in•lbf (10 N•m)
Utility Knife	
Pliers	Clip Clamp Pliers
Tape	Clear
Wrench	10mm
Socket	10mm, Extension, 10mm Deep
Special Chemicals	Notes
Cleaner	VDC Approved Cleaner
Glass Cleaner	Household Glass Cleaner

Legend

	STOP: Damage to the vehicle may occur. Do not proceed until process has been completed with.
	OPERATOR SAFETY: Use caution to avoid risk of injury.
	CAUTION: A process that must be carefully observed in order to reduce the risk of damage to the accessory/vehicle and to ensure a quality installation.
	TOOLS & EQUIPMENT: Used in Figures calls out the specific tools and equipment recommended for this process.
	REVISION MARK: This mark highlights a change in installation with respect to previous issue.
	SAFETY TORQUE: This mark indicates that torque is related to safety.

Care must be taken when installing this accessory to ensure damage does not occur to the vehicle. The installation of this accessory should follow approved guidelines to ensure a quality installation.

These guidelines can be found in the "Accessory Installation Practices" document.

This document covers such items as:

- Vehicle Protection (use of covers and blankets, cleaning chemicals, etc.)
- Safety (eye protection, rechecking torque procedure, etc.)
- Vehicle Disassembly/Reassembly (panel removal, part storage, etc.)
- Electrical Component Disassembly/Reassembly (battery disconnection, connector removal, etc.)

Please see your Toyota dealer for a copy of this document.

TVIP	Vehicle	Description
A	-	5P WHITE
B	-	5P WHITE
C	-	10P WHITE
D	-	10P WHITE
E	-	20P WHITE <i>for RES ECU</i>
F	-	5P WHITE <i>for Gateway ECU</i>
G	-	GROUND WIRE TERMINAL
H	-	2P WHITE
I	-	Gateway ECU
J	-	20P BLUE
K	-	20P BLUE
L	-	RES ECU
M	-	1P WHITE <i>(RES Diagnosis)</i>
N	-	1P WHITE <i>(RES Diagnosis)</i>

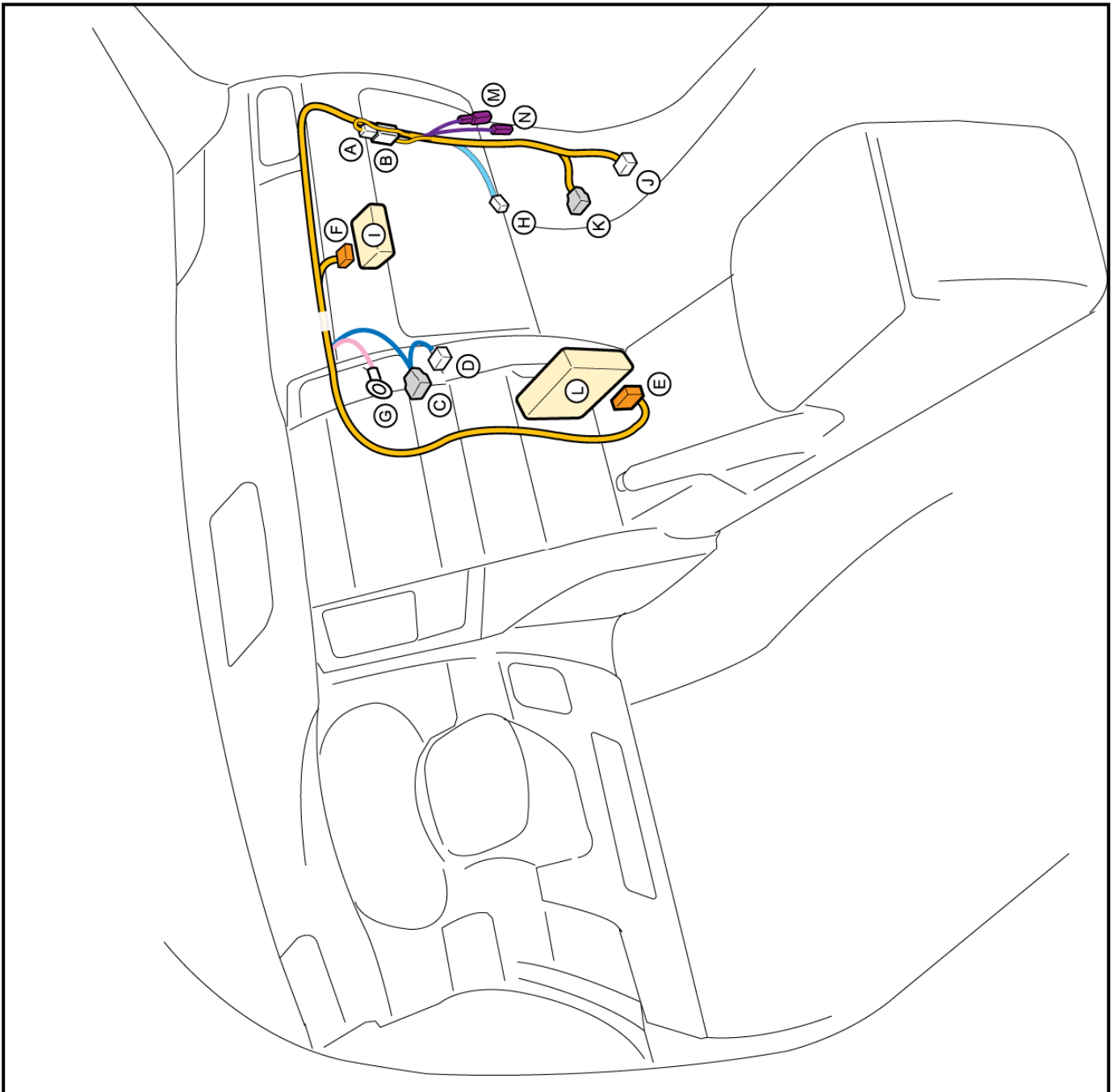

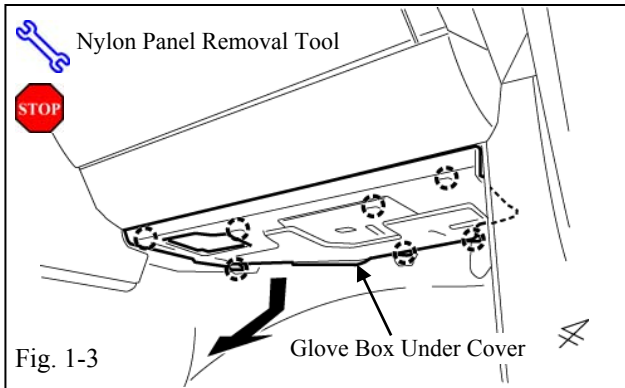

(c) Remove the Glove Box Under Cover.
(Fig. 1-3)



(1) Begin by protecting the Vehicle Interior with Blankets.

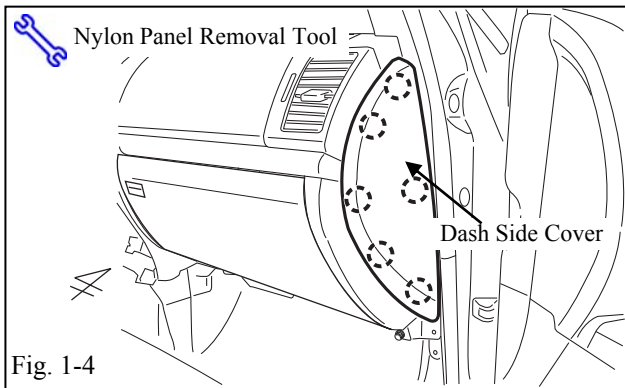

(d) Remove the Passenger's Side Dash Side Cover. (Fig. 1-4)

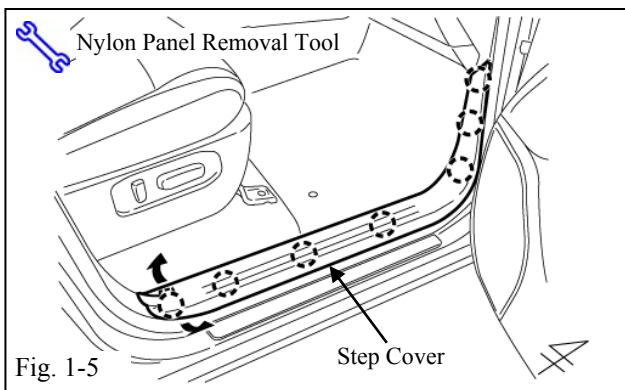

(e) Remove the Passenger's Side Step Cover.
(Fig. 1-5)

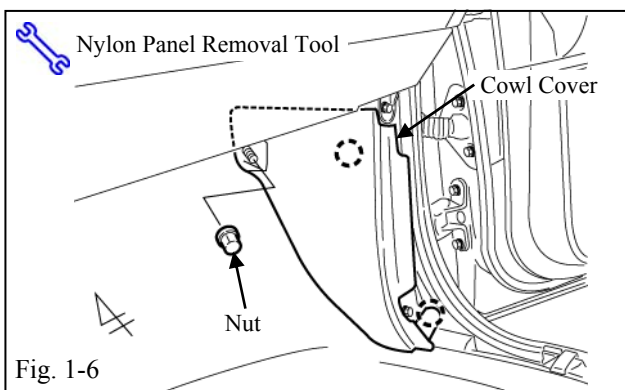

(f) Remove the Passenger's Side Cowl Cover.
(Fig. 1-6)

(1) Remove 1 Nut.

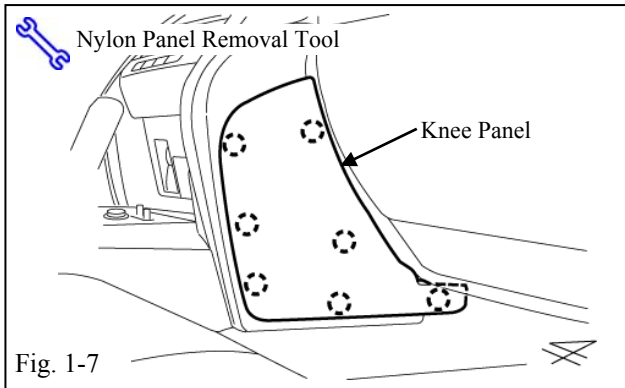

- (g) Remove the Passenger's Side Knee Panel. (Fig. 1-7)

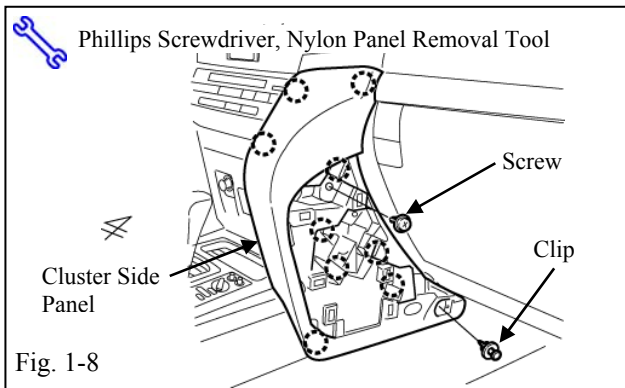

- (h) Remove the Passenger's Side Cluster Side Panel. (Fig. 1-8)
 - (1) Remove 1 Screw and 1 Clip.

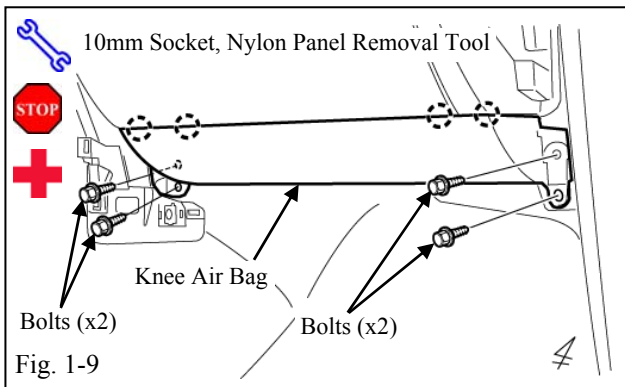

- (i) Remove the Passenger's Knee Air Bag. (Fig. 1-9)
 - (1) Remove 4 Bolts.
 - (2) Do not disconnect the Vehicle's Connector.



CAUTION: Sharp metal edges.

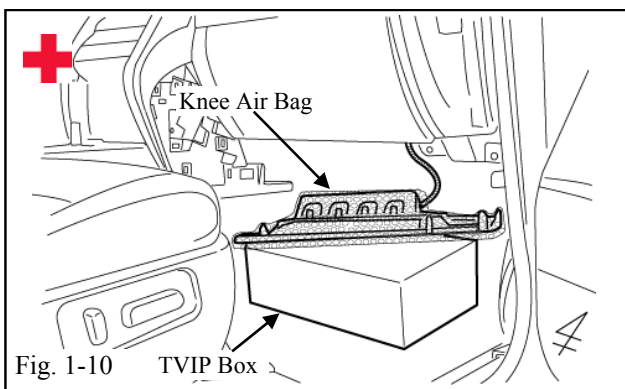

- (j) Wrap the Passenger's Knee Air Bag in a Blanket and use the TVIP Kit Box to support it. (Fig. 1-10)



CAUTION: Sharp metal edges.

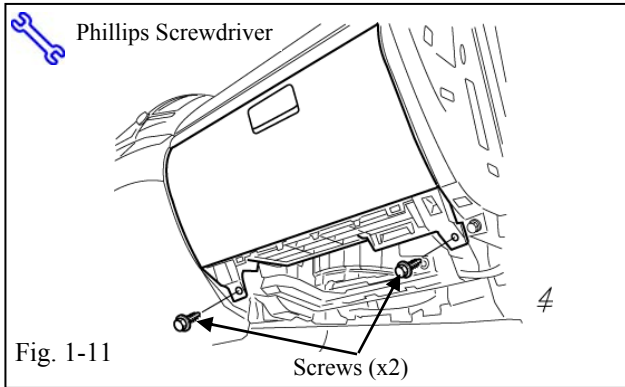

(k) Remove 2 Screws from the bottom of the Glove Box. (Fig. 1-11)

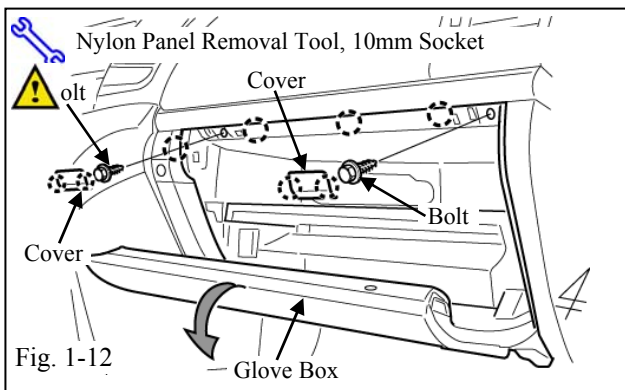

(l) Open the Glove Box, remove 2 Bolt Covers from the Glove Box. (Fig. 1-12)

(m) Dislodge the Glove Box (Fig. 1-12)

(1) Remove 2 Bolts.



NOTE: Pull down and out to avoid damaging the Vehicle Clips or Dash Trim.

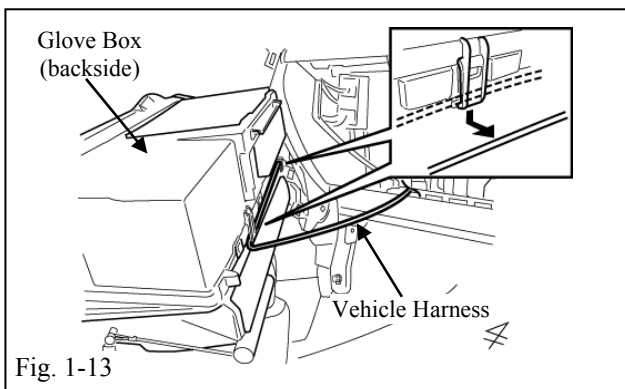

(n) Remove the Vehicle Harness from the backside of the Glove Box, remove the Glove Box. (Fig. 1-13)

(1) Disconnect any Connectors.

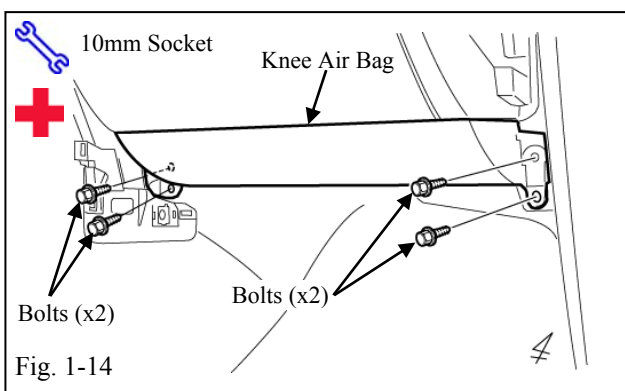

(o) Temporarily install the Passenger's Side Knee Air Bag. (Fig. 1-14)



CAUTION: Sharp metal edges.

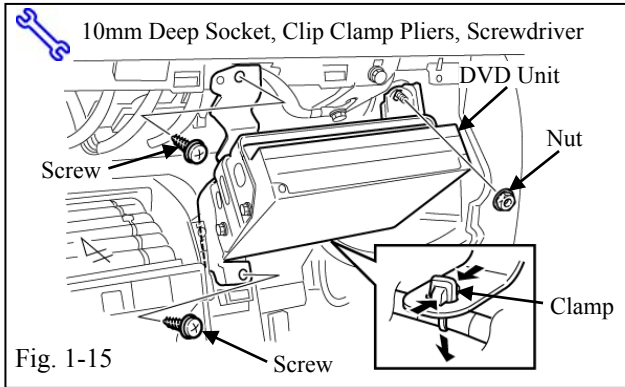

VEHICLES EQUIPPED WITH NAVIGATION SYSTEM.

- (p) Remove the DVD Unit from the Glove Box Area. (Fig. 1-15)
- (1) Remove 2 Screws and 1 Nut.
 - (2) Using the Clip Clamp Tool or the like, push on the inside the Vehicle Clamp, and release it from the DVD Unit.

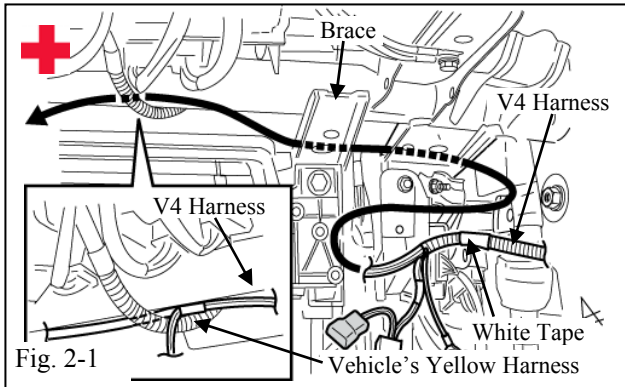

2. V4 Wire Harness Installation.

- (a) Route the V4 Harness behind the Vehicle Brace and Yellow Harness in the Glove Box area as shown. (Fig. 2-1)

+ CAUTION: Sharp metal edges.

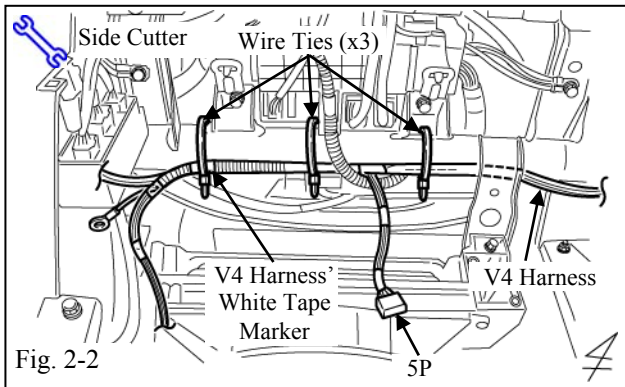

- (b) Secure the V4 Harness's White Taped Marker to the Reinforcement with 1 Wire Tie. (Fig. 2-2)
- (c) Secure the V4 Harness to the Reinforcement with 2 Wire Ties. (Fig. 2-2)

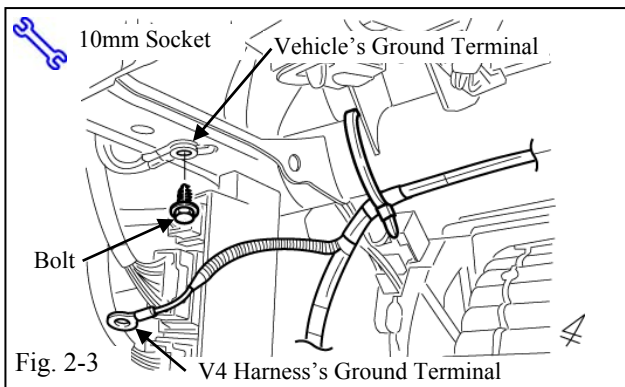

- (d) Locate and remove 1 Bolt from the Vehicle Ground Terminal in the upper left side of the Glove Box Area. (Fig. 2-3)
 - (1) Do not discard the Bolt.

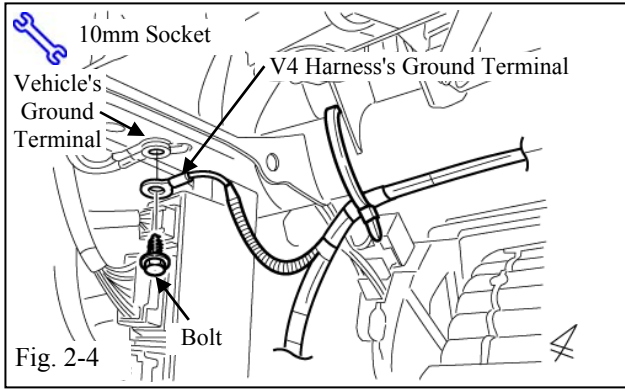

- (e) Use the existing Vehicle's Bolt to secure the V4 Harness's Ground Terminal with the Vehicle's Ground Terminal. (Fig. 2-4)
 - (1) Make sure that the Vehicle's Ground Terminal Pin seats properly.

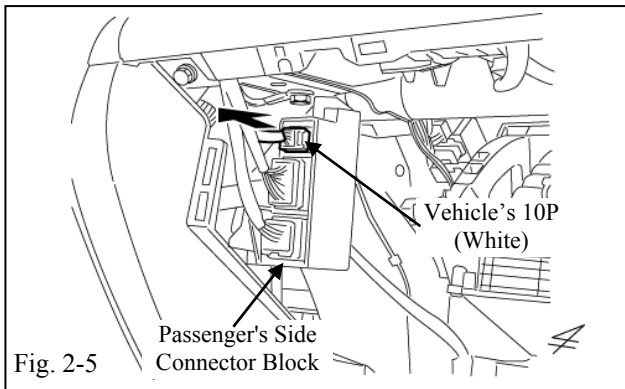

- (f) Locate and remove the Vehicle's White 10P Connector from the Connector Block in the Glove Box Area. (Fig. 2-5)

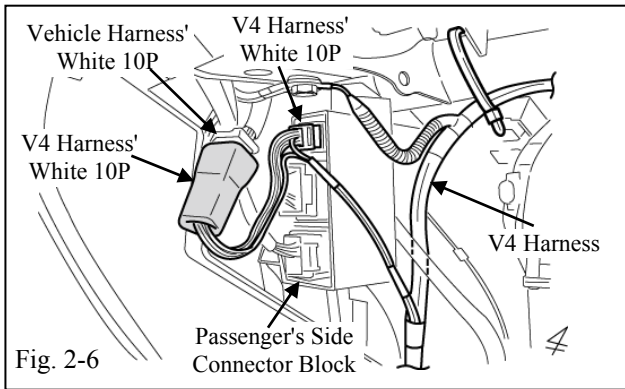

- (g) Plug in the V4 Harness's White 10P Connectors in between the Vehicle Harness's White 10P Connector and the Connector Block. (Fig. 2-6)
 - (1) Verify secure connection.

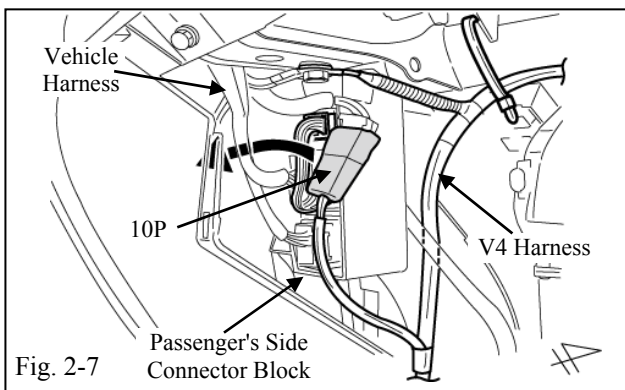

- (h) Push the 10P Connectors through the opening between the Vehicle Harness and the Passenger's Side Connector Block as shown. (Fig. 2-7)

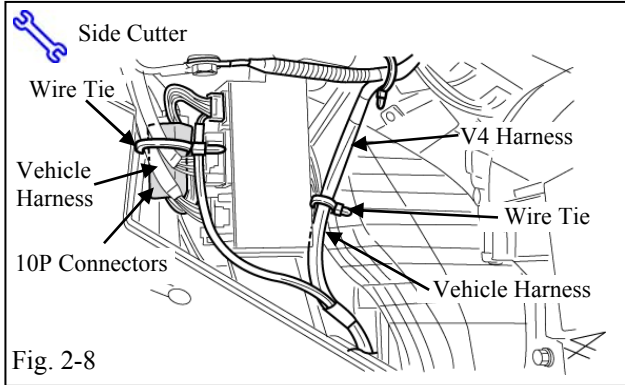

- (i) Secure the 10P Connectors to the Vehicle Harness with 1 Wire Tie. (Fig. 2-8)
- (j) Secure the V4 Harness to the Vehicle Harness behind the Passenger's Side Connector Block with 1 Wire Tie. (Fig. 2-8)

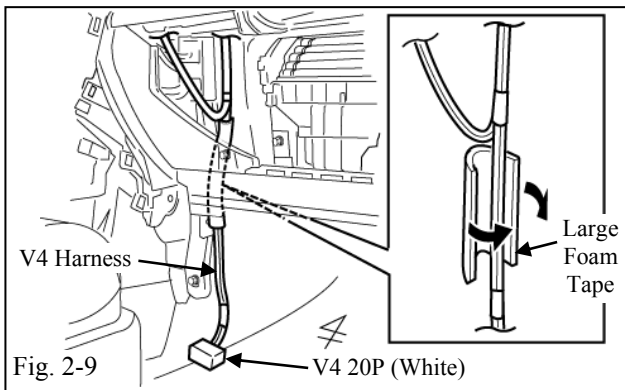

- (k) Wrap the V4 Harness's branch area with 1 Large Foam Tape as shown. (Fig. 2-9)
- (l) Route the V4 Harness's White 20P Connector toward the Vehicle's Floor. (Fig. 2-9)

3. RES ECU Preparation and Installation.

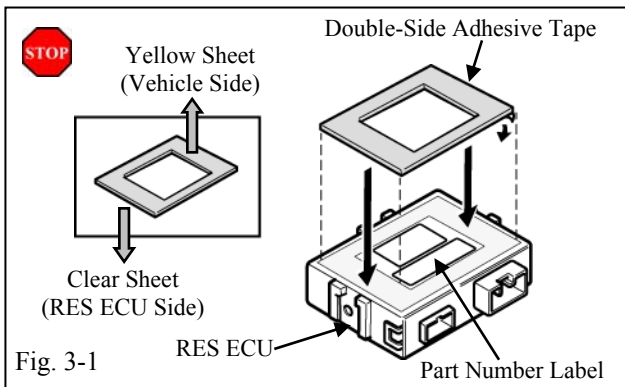

- (a) Remove the Clear Protective Sheet from the Double Stick Tape and attach it to the Part Number Label side of the RES ECU as shown. (Fig. 3-1)



- (1) Be sure to apply the Clear Sheet side on the RES ECU.



- (2) Be sure to attach adhesive tape on the part number label side of the RES ECU.



- (3) Do not cover the Part Number Label with the adhesive tape.



CAUTION: Do not touch the adhesive surface.

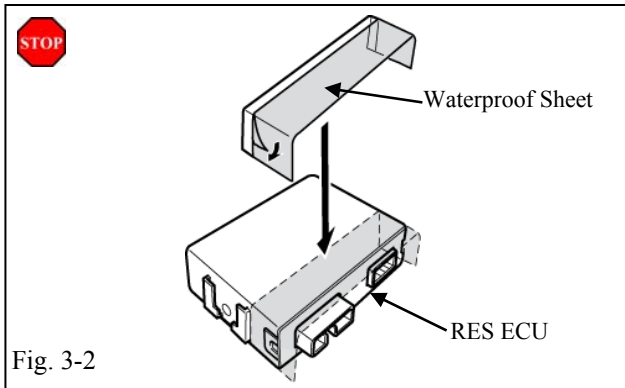

(b) Remove the Backing Sheet of 1 Waterproof Sheet and attach it to the RES ECU near the connectors as shown. (Fig. 3-2)

STOP CAUTION: Do not touch the adhesive surface.

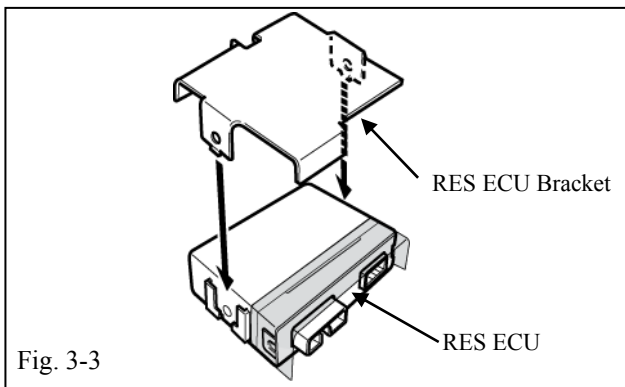

(c) Insert the RES ECU Bracket into the indicated Bracket Slots on the RES ECU. (Fig. 3-3)

(1) Ensure the Bracket is firmly attached to the ECU.

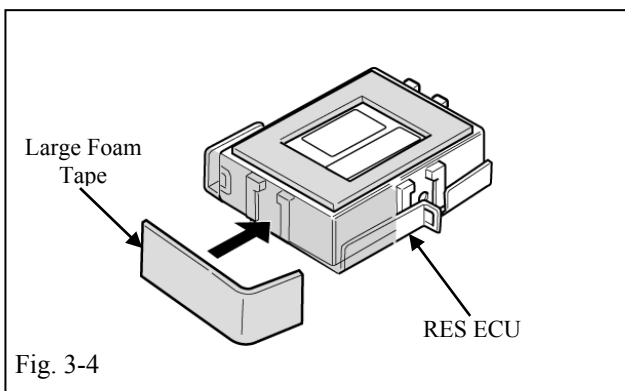

(d) Apply 1 strip of Large Foam Tape to the RES ECU as shown. (Fig. 3-4)

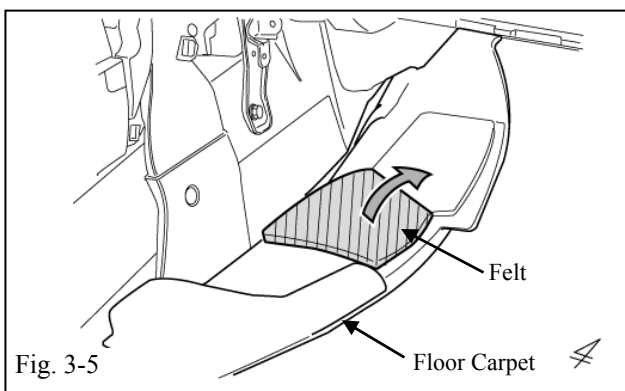

(e) Turn over the Floor Carpet on the left side of the Passenger's Side Area. (Fig. 3-5)

(f) Pull back the Felt on the backside of the Floor Carpet as shown. (Fig. 3-5)

(1) Do not remove or cut off the Felt.

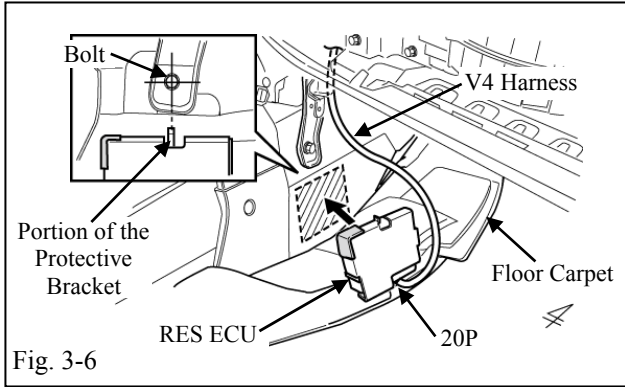

- (g) Connect the V4 Harness's White 20P Connector to the RES ECU. (Fig. 3-6)
- (h) Using the VDC approved cleaner and Cleaning Method, clean the area indicated on the left side of the Passenger's Side Floor. (Fig. 3-6)
- (i) Remove the Protective Sheet of the Double Stick Tape. (Fig. 3-6)
- (j) Center the RES ECU Bracket to Vehicle's Bolt as shown. Then press the RES ECU firmly to the Vehicle. (Fig. 3-6)
 - (1) Do not attempt to reposition the ECU once placed.

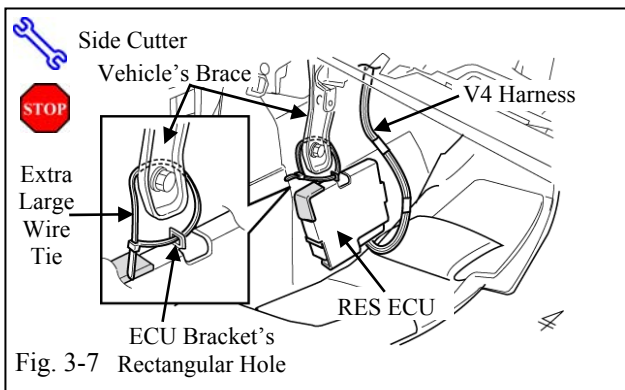

- (k) Run 1 Extra Large Wire Tie through the RES ECU rectangular hole and behind the Vehicle Brace and secure it. (Fig. 3-7)
 - (1) Do not tighten the Wire Tie, it should hang freely.

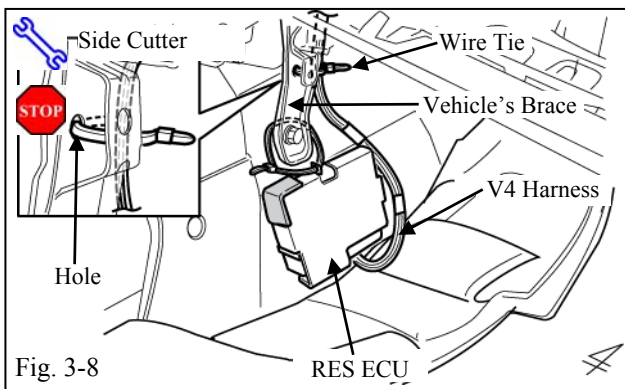

- (l) Secure the V4 Harness to the side of the inside Vehicle Brace with 1 Wire Tie as shown. (Fig. 3-8)
 - (1) Do not use the front hole of the Vehicle Brace.

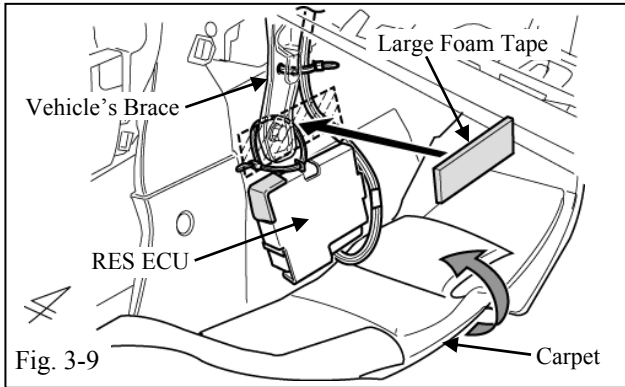

- (m) Attach 1 Large Foam Tape to the Vehicle's Brace and the V4 Harness as shown. then put the Carpet back. (Fig. 3-9)

GO BACK TO THE V4 HARNESS'S WHITE TAPE MARKER AREA.

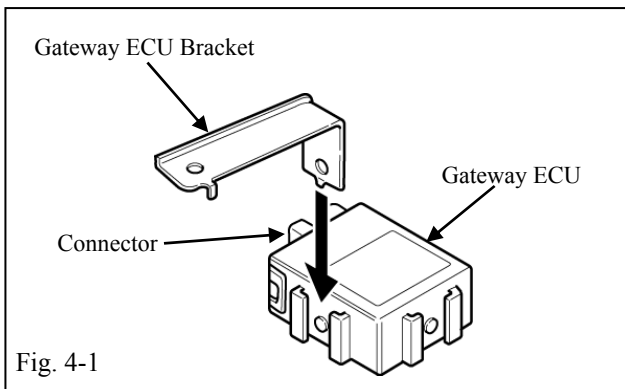

4. Gateway ECU Preparation and Installation.

- (a) Insert the Gateway ECU Bracket into the indicated Bracket Slots on the Gateway ECU. (Fig. 4-1)
 - (1) Ensure the Bracket is firmly attached to the ECU.

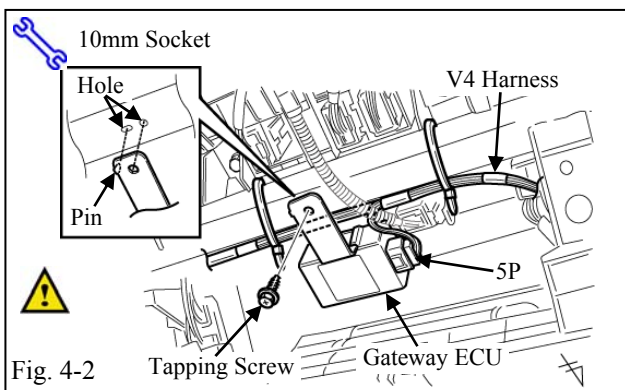

- (b) Connect the V4 Harness's White 5P Connector to the Gateway ECU. (Fig. 4-2)
 - (1) Verify secure connection.
- (c) Using the M6 Tapping Screw from the Kit, install the Gateway ECU Bracket. (Fig. 4-2)
 - (1) Make sure that the Bracket Pin seats properly.



CAUTION: Do not crimp the V4 and/or the V2 Harness between the Gateway ECU Bracket and the Vehicle Reinforcement Brace.

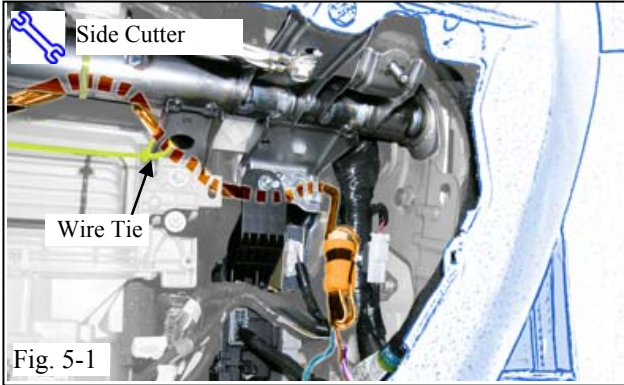

5. V4 Wire Harness Installation (continued).

- (a) Route the V4 Harness behind the Vehicle Brace and ECU Brackets as shown.
- (b) Secure the V4 Harness to the Vehicle Brace with 1 Wire Tie. (Fig. 5-1)



- (c) Locate the Vehicle's 5P White Connectors. (Fig. 5-2)
- (d) Disconnect the Vehicle's 5P White Connectors. (Fig. 5-2)

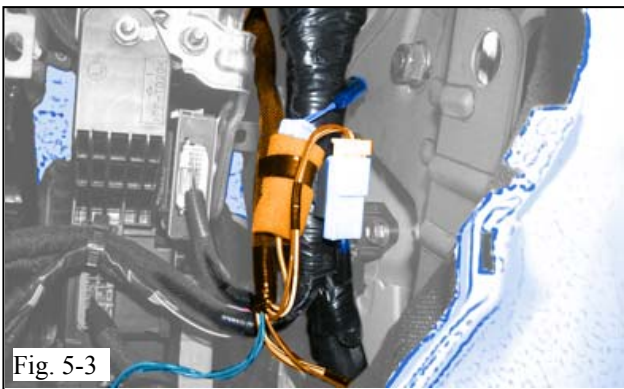

- (e) Connect the V4 5P Connectors in between the Vehicle's 5P Connectors. (Fig. 5-3)

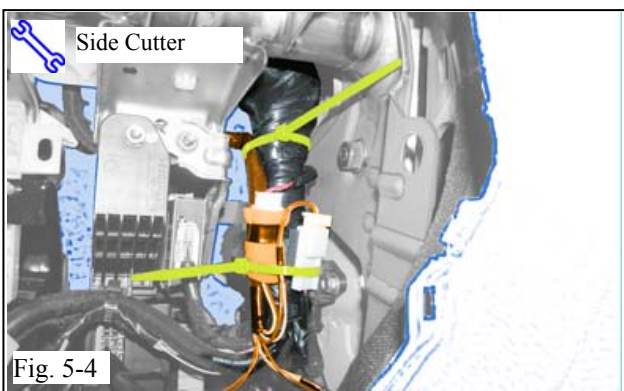

- (f) Secure the V4 Harness to the Vehicle Harness with 1 Wire Tie. (Fig. 5-4)
- (g) Secure the 5P Connectors to the Vehicle Harness with 1 Wire Tie. (Fig. 5-4)

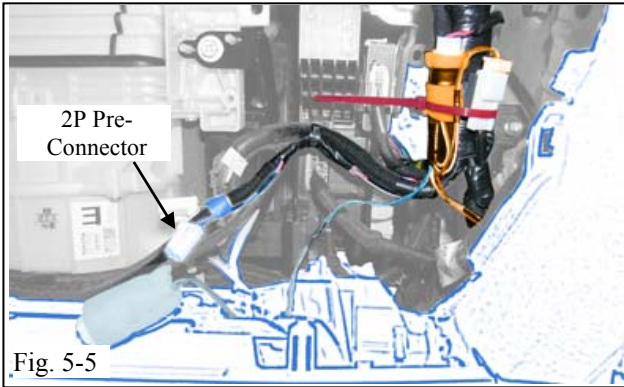

- (h) Locate the Vehicle's 2P Pre-Connector. (Fig. 5-5)
- (i) Remove the Break Away Tape from the Connector. (Fig. 5-5)

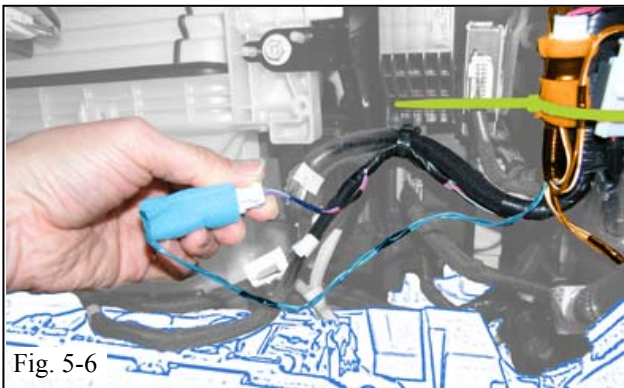

- (j) Connect the V4 2P Connector to the Vehicle's 2P Pre-Connector. (Fig. 5-6)

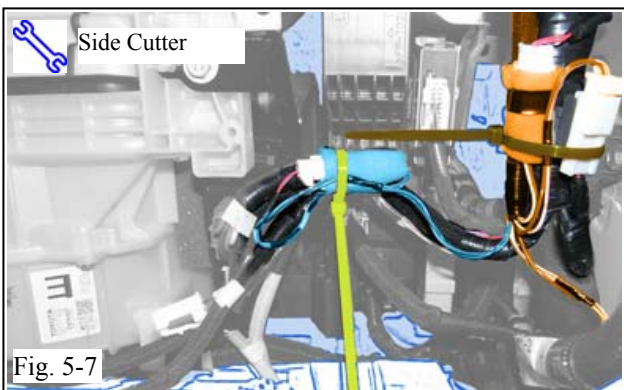

- (k) Secure the 2P Connectors to the Vehicle Harness with 1 Wire Tie. (Fig. 5-7)

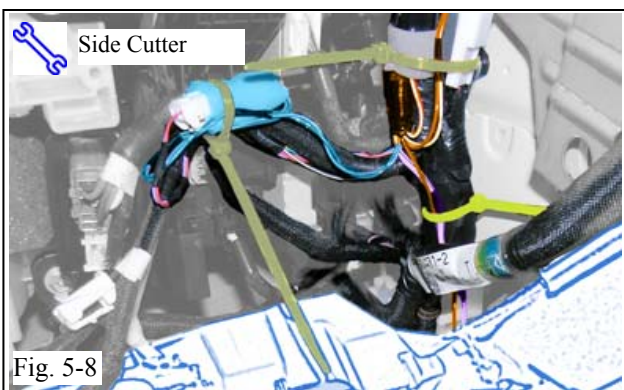

- (l) Route the remaining V4 Harness along the Vehicle Harness towards the Passenger's Cowl Area. (Fig. 5-8)
- (m) Secure the V4 Harness to the Vehicle Harness using 1 Wire Tie. (Fig. 5-8)

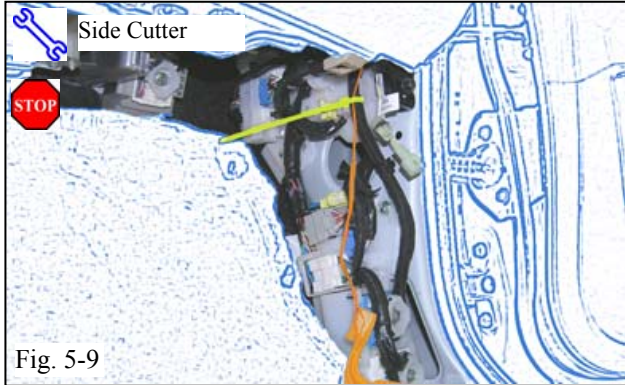

- (n) Route the remaining V4 Harness as shown. (Fig.5-9)

STOP CAUTION: Do not secure the V4 1P RES Diagnostic Connectors.

- (o) Secure the V4 Harness to the Vehicle Harness with 1 Wire Tie. (Fig. 5-9)

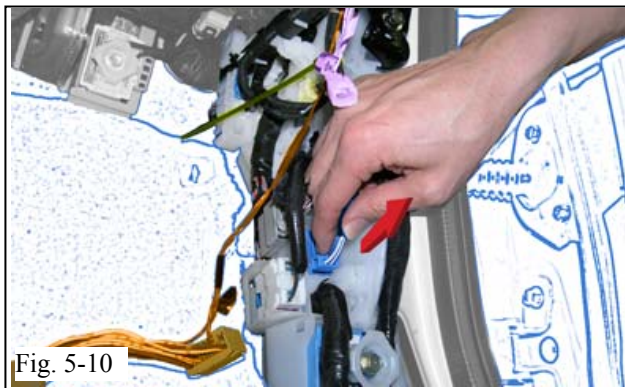

- (p) Disconnect the Vehicle's Blue 20P Connector from the Passenger's Side Cowl Area. (Fig. 5-10)

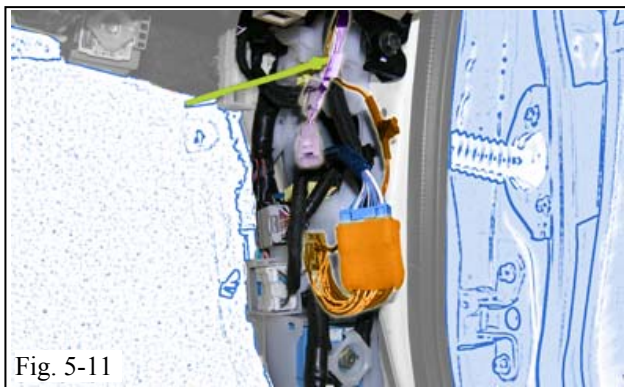

- (q) Connect the V4 20P Connectors in between the Vehicle's 20P Connectors. (Fig. 5-11)

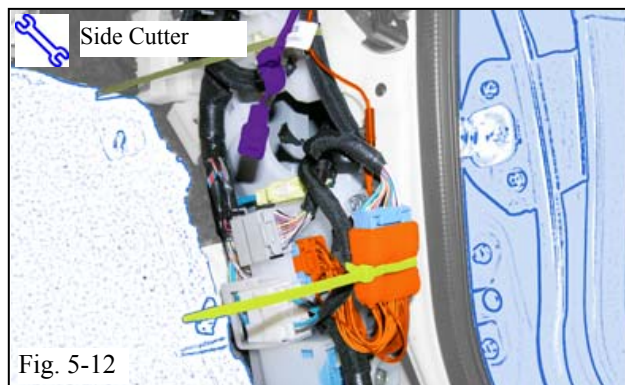

- (r) Secure the 20P Connectors to the Vehicle Harness with 1 Wire Tie. (Fig. 5-12)

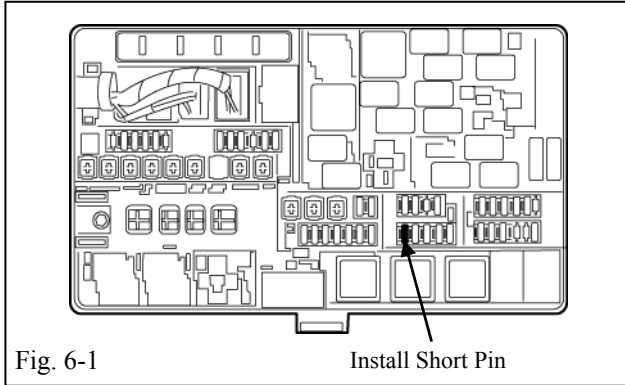

6. Partial Reassembly.

- (a) Reassemble the Vehicle, except for the Passenger's Cowl Cover, and Step Cover.



- (1) Reconnect any disconnected connectors.
- (2) Torque the Passenger's Knee Air Bag to 88.5 in•lbf (10 N•m).

- (b) Verify the Short Pin is installed. (Fig. 6-1)

- (1) If not, install the Short Pin.

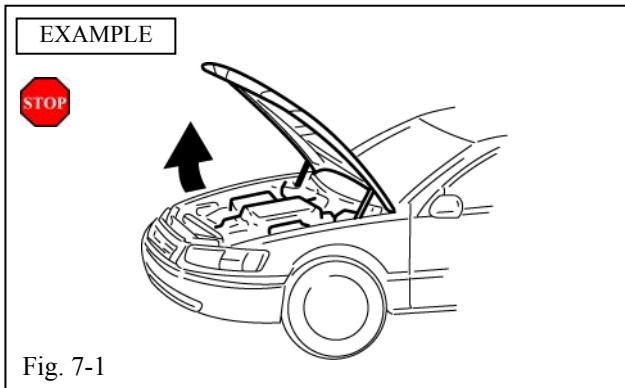

7. Registration Process.

- (a) Open the Hood. (Fig. 7-1)



Note: Do not close the Hood during the Registration Setting Procedure. (Steps b-cc)

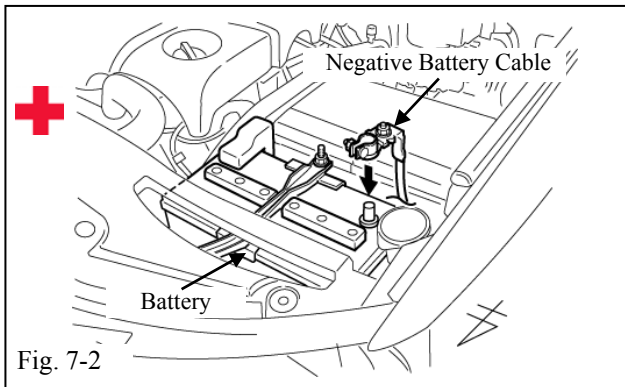

- (b) Temporarily reconnect the Vehicle's Negative Battery Cable. (Fig. 7-2)



CAUTION: Do not touch the positive terminal.

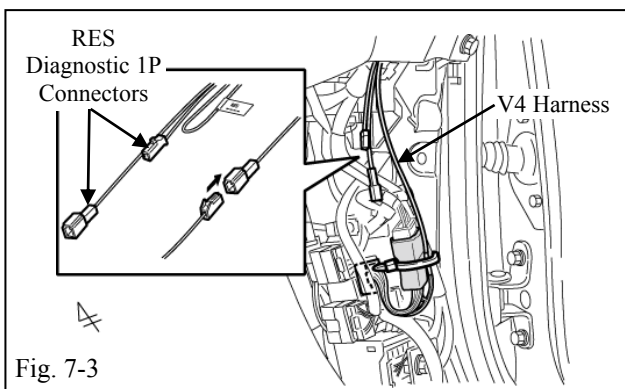

- (c) Locate the V4 Harness's 1P RES Diagnostic Connectors in the Passenger's Side Cowl Area, and remove the Tape. (Fig. 7-3)

- (d) Connect the 2 RES Diagnostic Connectors. (Fig. 7-3)

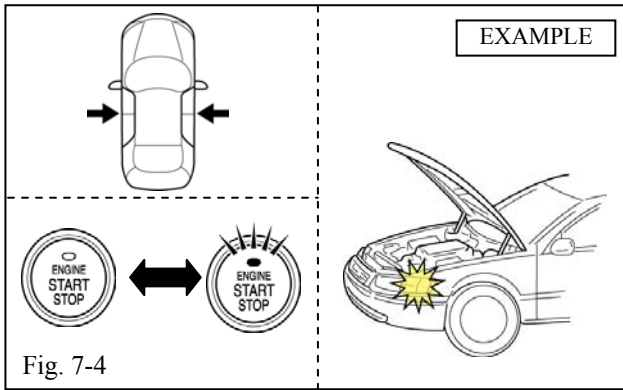

Fig. 7-4

- (e) Ensure all Doors are closed and the Smart Key is in your possession. (Fig. 7-4)
- (f) Cycle the Vehicle’s “Engine Start Stop” Button from “OFF” to “ON” 5 times. (Fig. 7-4)

(1) Place the Shift Lever in the "P" Position.

NOTE: One cycle consists of:

OFF→Accessory→ON

This is equivalent to pressing the “Engine Start Stop” Button 14 times.

- (g) Once the fifth cycle has been completed, the Hazard Lights Flash once. (Fig. 7-4)
- (h) Press the Vehicle’s “Engine Start Stop” Button once more to turn the ignition to OFF.

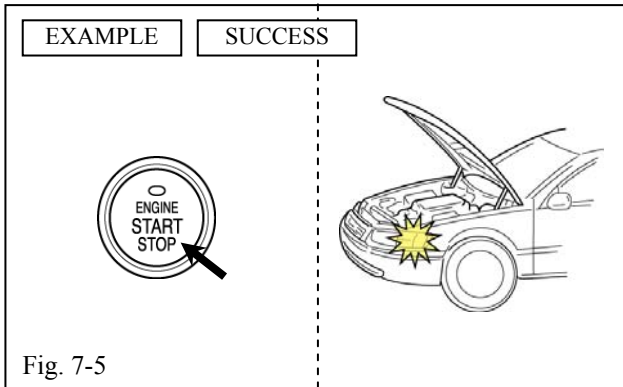

Fig. 7-5

- (i) Start the Engine, after 10 seconds stop the Engine. (Fig. 7-5)
- (j) The Hazard Lights flash once. (Fig. 7-5)

Go to step m.

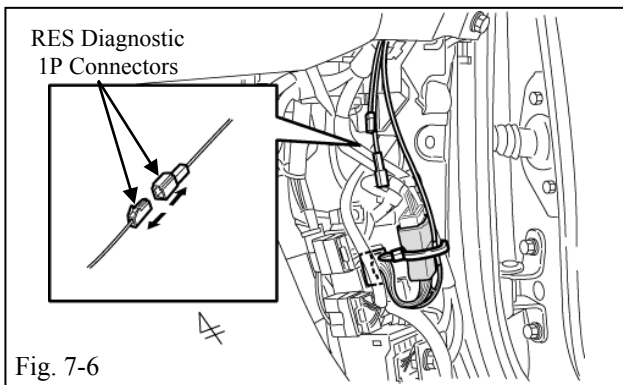

Fig. 7-6

- (k) If this procedure failed, the Hazard Lights flash twice.
- (l) Disconnect the RES Harness White 1P Connectors from the Passenger’s Side Cowl Area. (Fig. 7-6)

Start again from step d.

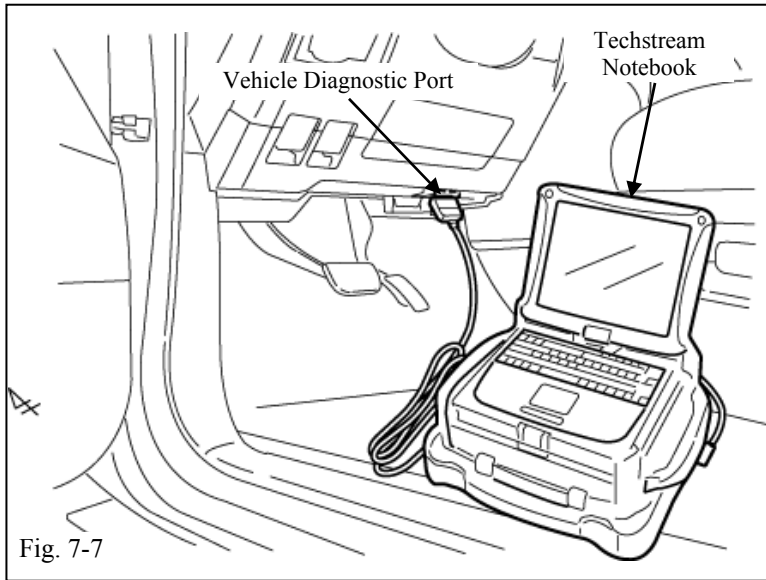

Fig. 7-7

STOP CAUTION: Techstream Lite will not work for this section, use the Techstream Notebook ONLY.

- (m) Connect the Techstream Notebook to the Vehicle's Diagnostic Port. (Fig. 7-7)
- (n) With the Remote Control Key in your possession, press the Vehicle's "Engine Start Stop" Button twice to select the Ignition "ON" position.

Note: Do not apply Brake Pedal.

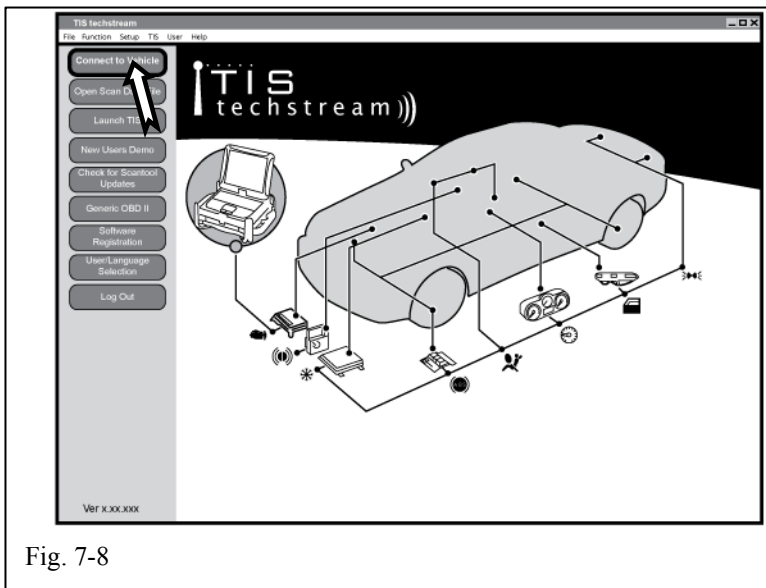

Fig. 7-8

- (o) Start the TIS Techstream Application by clicking on the shortcut located on the Desktop.
- (p) Click "Connect to Vehicle." (Fig. 7-8)

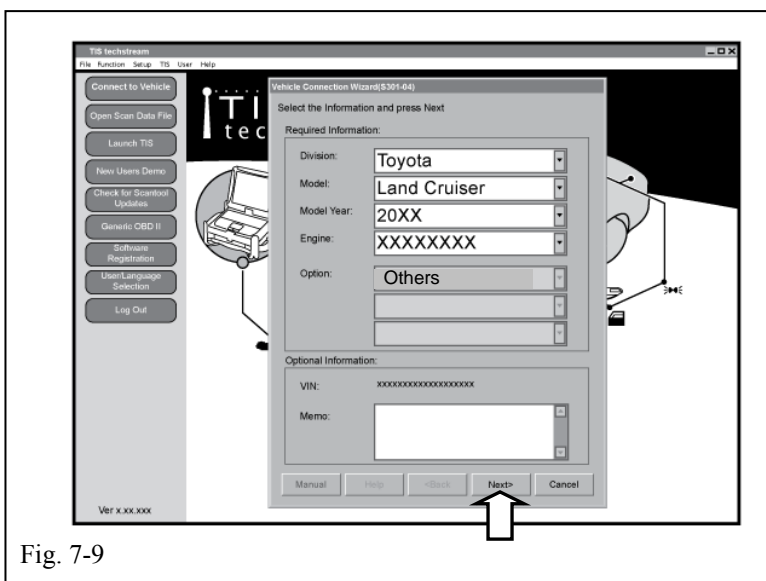

Fig. 7-9

- (q) Confirm that the information displayed on the Vehicle Connection Wizard is correct for the Vehicle. If not verify that the Techstream is properly connected. (Fig. 7-9)
- (r) Under Option, select "Others" then Click "Next>." (Fig. 7-9)

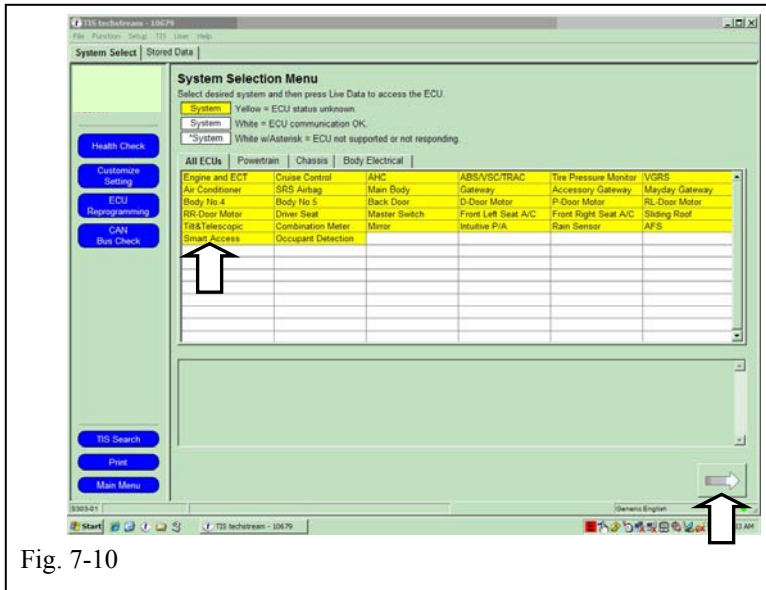

Fig. 7-10

- (s) Select “Smart Access.”
(Fig. 7-10)

- (t) Click . (Fig. 7-10)

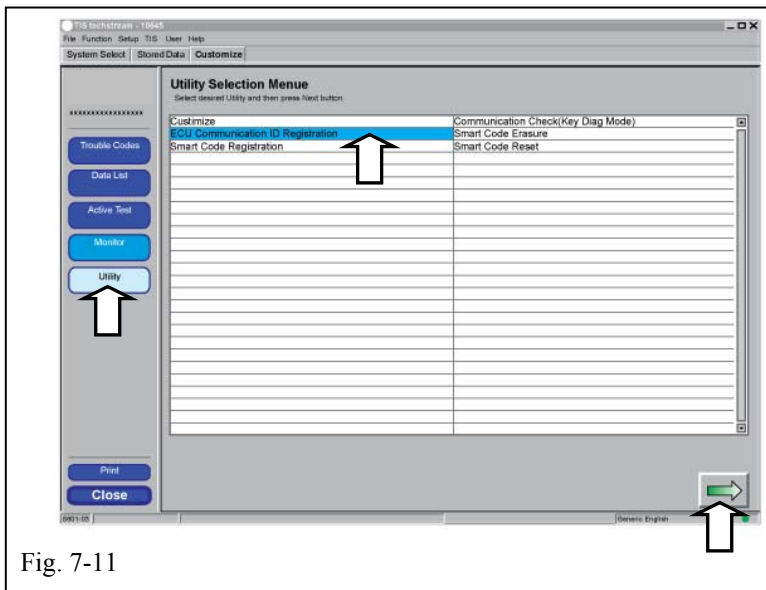



Fig. 7-11

- (u) Click on “Utility.” (Fig. 7-11)

- (v) Select “ECU Communication ID Registration.” (Fig. 7-11)

- (w) Click . (Fig. 7-11)

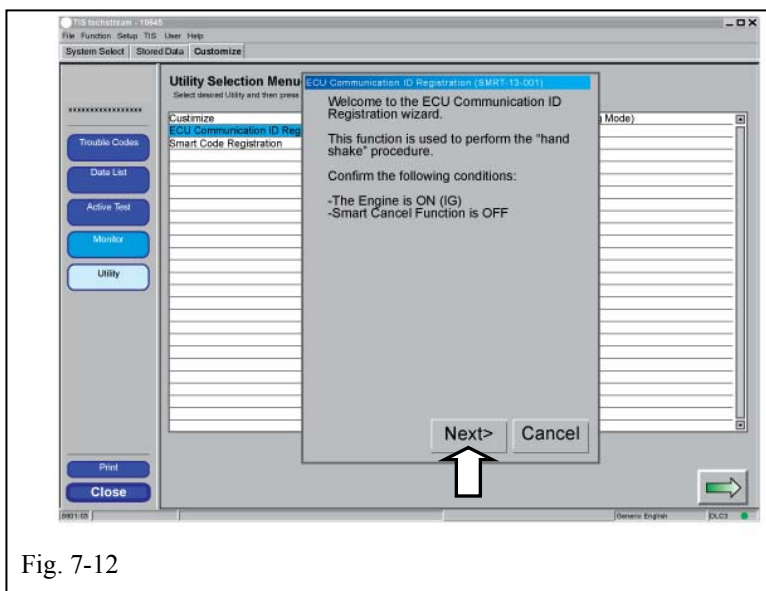

Fig. 7-12

- (x) Confirm that the Engine is ON (IG), and that the Smart Cancel Function is OFF. (Fig. 7-12)

- (y) Click “Next>” to continue. (Fig. 7-12)

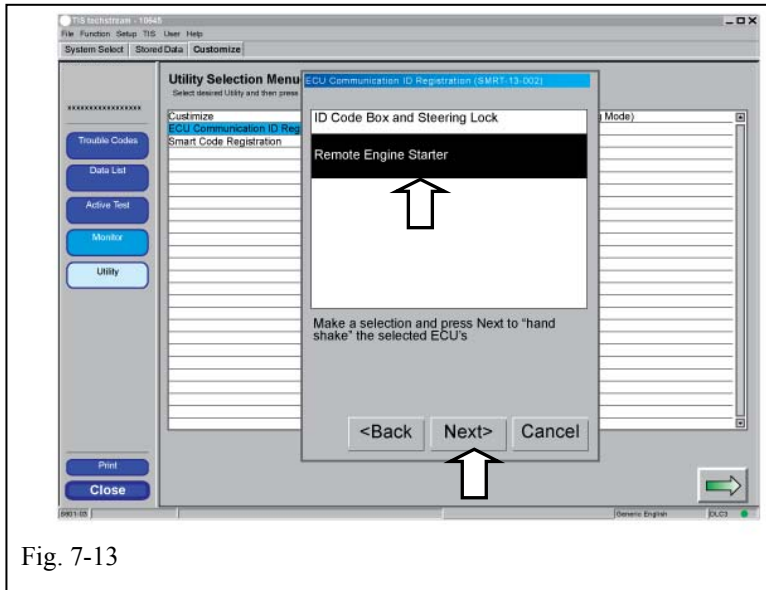

Fig. 7-13

(z) Select “Remote Engine Starter.”
(Fig. 7-13)

(aa) Click “Next>” to continue.
(Fig. 7-13)

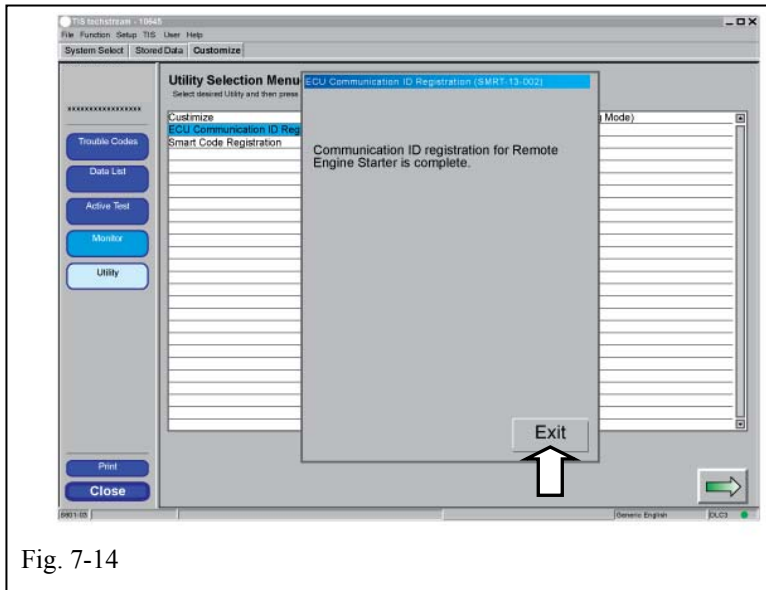

Fig. 7-14

(bb) Click “Exit.” (Fig. 7-14)

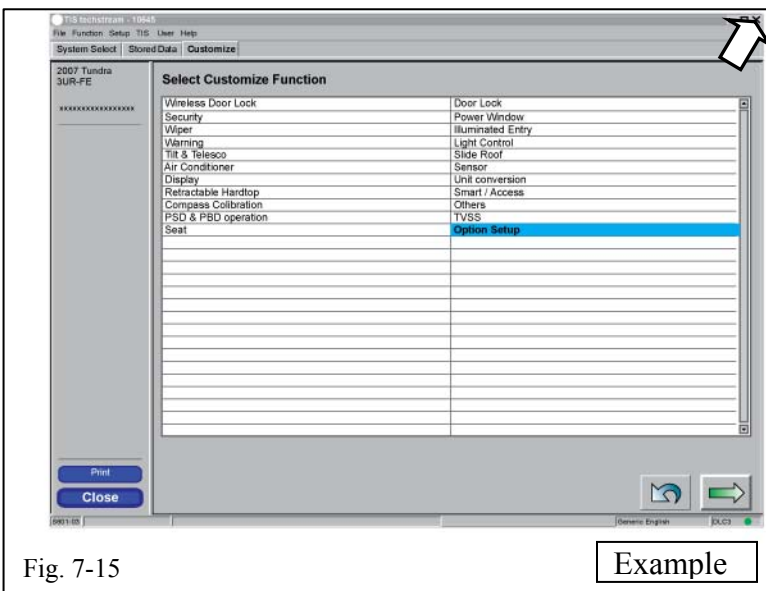
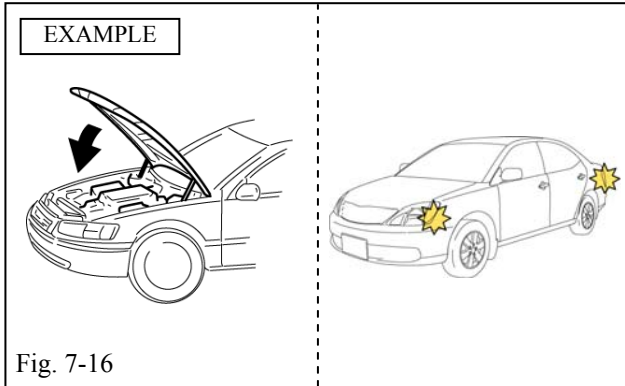

Fig. 7-15

Example

(cc) Click . (Fig. 7-15)



- (dd) Close the Hood. (Fig. 7-16)
- (ee) The Hazard Lights flash twice. Registration is completed (Fig. 7-16)

If this procedure failed, the Hazard Lights flash 3 times. Registration was not set.

- Disconnect the 1P RES Diagnostic Connectors, then open the Hood.

Start again from Step d.

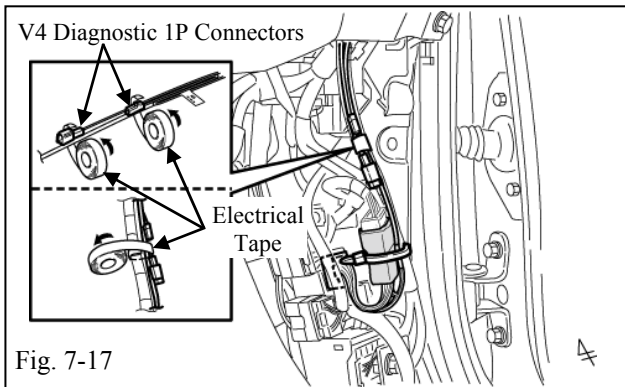

- (ff) Disconnect the V4 Harness's 1P RES Diagnostic Connectors. (Fig. 7-17)
- (gg) Secure the V4 Harness and 1P Connectors with Electrical Tape as shown. (Fig. 7-17)
- (hh) Secure the V4 Harness to the Vehicle Harness with the Electrical Tape as shown. (Fig. 7-17)
- (ii) Press the Vehicle's "Engine Start Stop" Button to place the Vehicle in the "OFF" (Indicator Light off) position.

8. Tags and Label Installation.

- For US Vehicles use the English Labels and discard the Spanish Labels.
- For Mexico Vehicles use the Mexico Labels, and discard the English Labels.

(a) Remove 2 of the Remote Controls from their protective bag.

(1) Use a utility knife, to cut a slit in each bag.

(b) Using VDC approved cleaner and Cleaning Method, clean the area indicated on the Remote Controls. (Fig. 8-1)

(c) Attach the Key Label to the Remote Controls as shown. (Fig. 8-1)

(1) Use a piece of the clean adhesive tape to lift the labels off their protective backing.

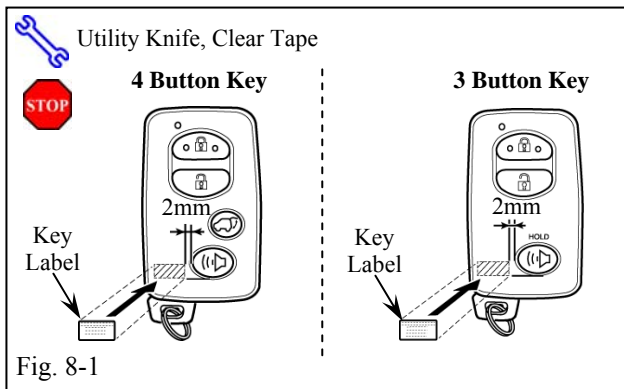

STOP CAUTION: Do not touch the adhesive surface.

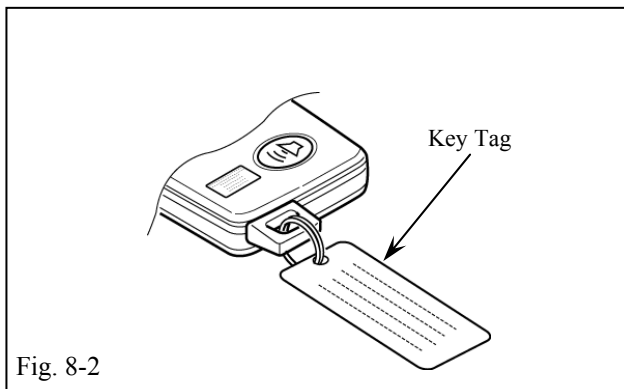

(d) Attach the Remote Engine Starter Tags to the Vehicle Remote Controls. (Fig. 8-2)



(e) Using VDC approved cleaner and Cleaning Method, clean the area indicated on the Engine Compartment Cover.(Fig. 8-3)

(f) Attach the Warning Label to the Engine Compartment Cover as shown. (Fig. 8-3)

STOP CAUTION: Do not touch the adhesive surface.

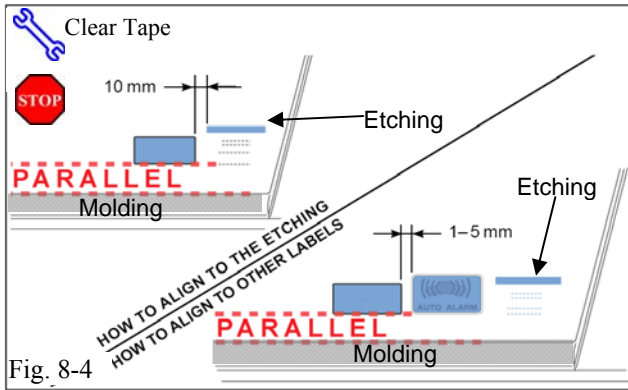

Fig. 8-4

- (g) Use Household Glass Cleaner to clean the inside of the Front Door Window. (Fig. 8-4)
- (h) Use a piece of Clear Tape to lift the Label off its protective backing.



CAUTION: Do not touch the adhesive surface.

- (i) Attach the Label as shown. (Fig. 8-4)



NOTE: Make sure to Align according to Etching or Other Label. (Fig. 8-4)

REPEAT: steps g–i with the other Window.

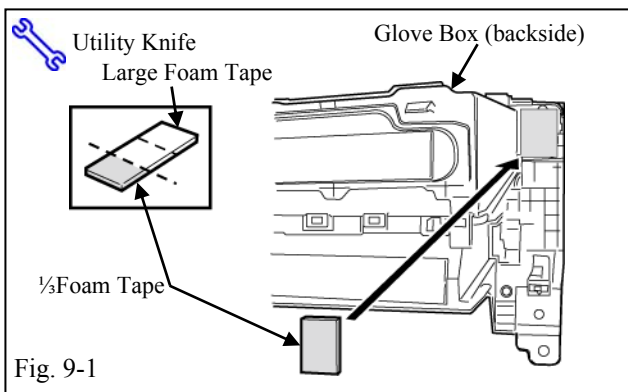

Fig. 9-1

9. Completing the Installation.

- (a) Cut and apply 1/3 piece of Large Foam Tape to the backside of the Glove Box. (Fig. 9-1)
- (b) Complete the reassembly of the Vehicle.



- (1) Verify the Panels fit together properly, with no uneven gaps.

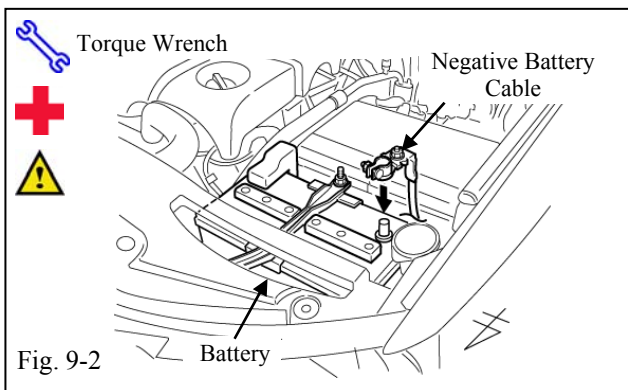

Fig. 9-2

- (c) Position the Negative Battery Cable at the original factory position. (Fig. 9-2)

- (1) Tighten the Nut to 36 in•lbf (4.07 N•m)



CAUTION: Do not touch the positive terminal.

- (d) Clean up and remove any Trash.
- (e) Sealed in its protective Bag, place the Owner’s Guide in the Glove Box.
- (f) Reset the power windows.
 - (1) Press the Power Button to select the Ignition “ON” position.
 - (2) Push down on the Power Window Switches lowering the windows halfway.
 - (3) Pull up on the switches until the windows close
 - (4) Continue holding up on the Switches for a minimum of 1 second.

Accessory Function Checks

Close the hood, enter the vehicle and close all doors. Place the shift lever in the “P” (Park) position, set the parking brake and make sure the Vehicle is off.

Perform		Look For
1	Press the remote control’s lock button twice within 2 seconds, then press and hold the lock button for 3 seconds.	The hazard lights flash after 3 seconds. The engine starts. The hazard lights flash repeatedly for 20 seconds.
2	With the engine running, pull the hood release handle. NOTE: <i>Some Vehicles may require you to exit the Vehicle and pull up on the Hood.</i>	The engine stops. The hazard lights flash once. The security alarm triggers (only if equipped with OE Factory Alarm, not Genuine Accessory alarm, and only if armed)
3	Move the shift lever out of “P” (Park). Attempt to start the Vehicle using the remote.	The engine does not start.

Vehicle Appearance Check

Perform		Look For
<input type="checkbox"/>	After accessory installation and removal of protective cover(s), perform a visual inspection of the vehicle.	Ensure no damage (including scuffs and scratches) was caused during the installation process. (For PPO installations, refer to TMS Accessory Quality Shipping Standard.)

Vehicle Function Check

	Function		Function
<input type="checkbox"/>	Head Light	<input type="checkbox"/>	ABS Light (if equipped) <i>If the warning light remains on, it may indicate a system malfunction.</i>
<input type="checkbox"/>	High Beams	<input type="checkbox"/>	Rear Wiper/Washer (if equipped)
<input type="checkbox"/>	Turn Signal Lights	<input type="checkbox"/>	Clock (if equipped)
<input type="checkbox"/>	Tail Lights	<input type="checkbox"/>	Accessory Power Socket (if equipped)
<input type="checkbox"/>	Stop Lights	<input type="checkbox"/>	Starter
<input type="checkbox"/>	Backup Lights	<input type="checkbox"/>	Audio/Video (if equipped)
<input type="checkbox"/>	Hazard Lights	<input type="checkbox"/>	Power Sliding Door (if equipped)
<input type="checkbox"/>	Marker Lights	<input type="checkbox"/>	Convenience Memory Settings (if equipped)
<input type="checkbox"/>	Dome/Courtesy Lights	<input type="checkbox"/>	Heated Seats (if equipped)
<input type="checkbox"/>	Panel/Switch Illumination	<input type="checkbox"/>	Massage Seats (if equipped)
<input type="checkbox"/>	Accessory Controls/Illumination (if equipped)	<input type="checkbox"/>	Rear Window Defogger (if equipped)
<input type="checkbox"/>	Key Sensor Buzzer	<input type="checkbox"/>	Power Side Mirrors (if equipped)
<input type="checkbox"/>	Fog Lights (if equipped)	<input type="checkbox"/>	Side Mirror Defogger (if equipped)
<input type="checkbox"/>	Daytime Running Lights (if equipped)	<input type="checkbox"/>	Front Windshield Defogger (if equipped)
<input type="checkbox"/>	Trunk/Tailgate/Bed Lights (if equipped)	<input type="checkbox"/>	Navigation System (if equipped)
<input type="checkbox"/>	Glove Box Light (if equipped)	<input type="checkbox"/>	Rear Sunshade (if equipped)
<input type="checkbox"/>	Cruise Control Light (if equipped)	<input type="checkbox"/>	Steering Wheel Audio Control (if equipped)
<input type="checkbox"/>	Seat Belt Warning Light <i>If the warning light remains on, it may indicate a system malfunction.</i>	<input type="checkbox"/>	Steering Wheel Column Adjusts Without Interference

	Function		Function
<input type="checkbox"/>	Air Bag Warning Light <i>If the warning light remains on, it may indicate a system malfunction.</i>	<input type="checkbox"/>	Lamp Failure Sensor <i>If the warning light remains on, it may indicate a system malfunction.</i>
<input type="checkbox"/>	Track/Skid Control Light (if equipped) <i>If the warning light remains on, it may indicate a system malfunction.</i>	<input type="checkbox"/>	Front Wiper/Washer
<input type="checkbox"/>	HVAC	<input type="checkbox"/>	Hood Latch Release
<input type="checkbox"/>	Power Locks (if equipped)	<input type="checkbox"/>	Passenger Air Bag Switch (if equipped)
<input type="checkbox"/>	Power Windows (if equipped)	<input type="checkbox"/>	Rollover Side Curtain Air Bag Switch (RSCA) (if equipped)
<input type="checkbox"/>	Power Seats (if equipped)	<input type="checkbox"/>	Tire Pressure Monitoring System (TPMS) (if equipped) <i>Prior to TPMS activation and Pre-delivery Service (PDS) of the Vehicle the TPMS light will blink when IG is turned on.</i> <i>After TPMS activation and PDS of the Vehicle the TPMS light will illuminate for a few seconds and go off when IG is turned on.</i>
<input type="checkbox"/>	Horn		
<input type="checkbox"/>	Gauges		
<input type="checkbox"/>	Power Sunroof (if equipped)		

Remove the short pin after Function check.
Check with your Port/Dealer to see if this step is necessary.

